

Wellness systems.

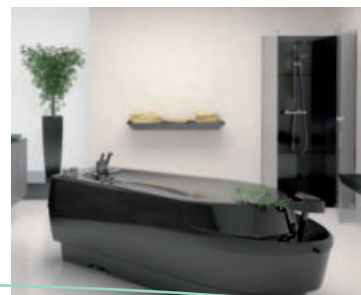
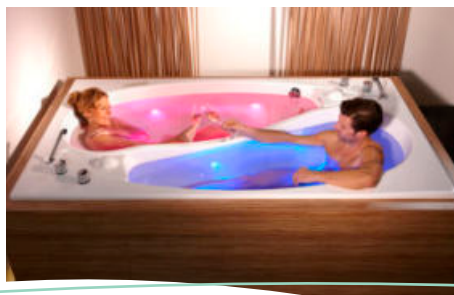

Nominal fee € 4,00 / SFR 7,00

4. edition

Technology for all Senses. **TRAUTWEIN**

Technology for all senses.

We have been perfecting our products since 1928. With an eye for detail, and a philosophy based on functionality and dependability, we develop unusual well-being solutions for spas and wellness facilities.

Technology for the senses that will delight your guests.

Trautwein baths and tables offer the very best in wellness appliances. Close cooperation with therapists and doctors, together with our own experience and expertise, form the basis of our global success. Our numerous patents, plus the many innovative features found in our equipment speak for themselves. You will find Trautwein products in more than 80 countries worldwide. The Castello del Sole in Ascona and the AIDA club cruise ships are just two companies convinced by the quality and tangible outcomes delivered by our sophisticated wellness products.

You can find more references at www.trautwein-gmbh.com or at the back of this brochure.





When everything has to be perfect.

If everything's perfect, you are most likely using Trautwein products. The high demands we place on ourselves are your guarantee for effectiveness and an unbeatable lifespan of reliability.

You'll find advanced technology and lots of intelligent ideas in each of our highly functional and easy-to-use wellness systems. Even more, our products come in a wide variety of designs and materials, and in a range of modern colours providing an attractive complement to any room decor.

A valuable advantage of our products is, while your customers are using them, your team can take care of other clients in another room.

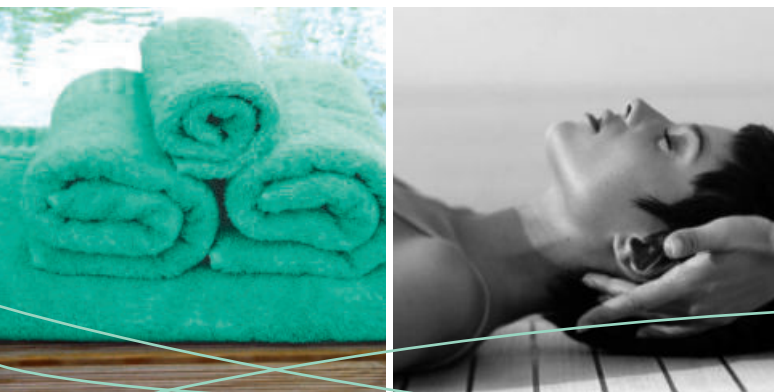

TOP QUALITY.

High quality materials are essential to the durability of a product. This is why Trautwein baths are made of a superior sanitary acrylic material and only high quality fittings are used. The fully dyed, easy-care material retains its hygienically smooth surface and brilliant shine for decades.

WELLNESS COMBINED WITH EXCELLENT VALUE.

Nowadays, candles and a sweet-smelling aroma are not enough to impress a Wellness guest – they can have this at home easily and less expensive. This is why Trautwein baths offer much more ... underwater massage, sound waves and coloured light to name but a few of our original details. Guests will recognise these wonderful benefits and after one Trautwein bath they want to repeat the experience!

Contents.



Hydroxeur® 6-11



California Twin & Rendezvous Yin Yang 12-17



Vis à vis & Sole Mio 18-19
Vis à Vis 1000 20-21



Twaèli 22-23



Thermo-Spa & Lady-Spa 24-29



AquaThermoJet 30-33



Wet massage table 34-35



Vichy Rainbow Shower 36-37



Final notes 38-40
References
About us

TECHNICAL DETAILS.

Pre-assembly drawings and detailed technical descriptions are provided in the main catalogue for all equipment available. Tub and covering materials in the Trautwein range of colours are offered at no extra charge.

REMARKS.

Please be aware: In this brochure the photos can show chargeable options. We will be happy to provide detailed quotations on request.

Due to technical and optical innovations the original appliance can differ from the photo and details of explanation.

Aromatic bathing pleasure.



A pleasing aroma turns your bath into a luxurious experience. Trautwein offers professional bath additives containing natural essential oils and plant extracts for a stress-relieving, aromatic massage bath. Our bath additives are highly concentrated so very little of the product is required: one bottle lasts for up to 50 baths. Trautwein is always developing new, innovative products to perfect the bathing experience. You can find the latest information on our website.



SPECIALLY FOR HYDROXEUR® WHIRLPOOLS.

Our bath additives have been specially formulated for the Hydroxeur® whirlpool. The surge bath emits fine swirls and eddies that create millions of tiny air bubbles. These bubbles mix our fragrant additives with the water creating a unique, aromatic champagne effect. The ultimate experience in therapeutic wellness bathing.

TRAUTWEIN'S RANGE OF SCENTS.

- > Harmony Spa with chamomile: balancing and calming.
- > Rosemary Spa: refreshing and revitalising.
- > Fantasy Spa with mint and lemon balm: soothing and relaxing.
- > Activity Spa with mountain pine: revitalising and stimulating.
- > Natural Spa without a scent: for intensive additional bubbles.
- > Tropical Spa with mango: revitalising, increases power of concentration.
- > Citronella Spa: refreshing, stimulating and mind raising.
- > Green Tea Spa with green tea and roses: requickening and comforting.

Just try it – it is unique



TAKE A TEST BATH.

Experience Trautwein's philosophy of functionality and dependability. Discover the amazing quality of our products. You can try out our wellness systems at our headquarters in Emmendingen (Baden-Württemberg) and at the companies that sell our products. Treat yourself to a relaxing experience in one of our massage whirlpools or try out our other latest

innovations. Experience our products and we are sure you will be thrilled! Your guests could be, too!

We would be happy to tell you which of our distribution partners is nearest to you. Simply give us a call to make an appointment, with no obligations, on +49 (0) 7641 / 4677-30.



APPLICATIONS.

Relaxing in our Hydroxeur® baths is a treat for all your senses. Up to 290 ergonomically arranged nozzles provide an unusually intensive and bubbly massage. Emulating the skills of an experienced therapist, the massage begins at the soles of your feet and makes its way up to your neck, continuing this pleasant full-body experience for the duration of whichever programme you choose.

With a Hydroxeur® you can offer a wide variety of bathing options, be it a detox treatment, aromatherapy or Thalassotherapy, all of which the Hydroxeur® is equipped to handle. The bath is also available with special fittings for thermal, mineral and sea water.

The Hydroxeur® principle.

Our Hydroxeur® whirlpool baths make use of a unique principle that mixes fine bubbles into the water. This champagne effect results in a top-quality underwater massage and has a therapeutic effect that is one of a kind. For those who prefer the finer things in life, Trautwein offers the Royal, Atlantis, Florida and California Hydroxeur® models. For us, top-quality wellness is not only about health benefits; it's also about technological features of the highest quality and innovation.



Control panel
ROYAL 600
ATLANTIS 500



Control panel
FLORIDA 300



Control panel
CALIFORNIA 300

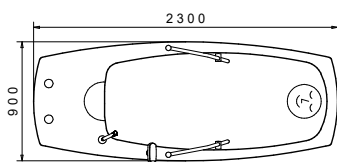
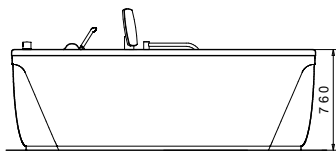

Dimensions Omega cladding

Royal 600
Atlantis 500
Florida 300
California 300

HYDROXEUR® >
with on-site tiling



EFFECTS.

- > Relieves tensions.
- > Reduces cellulitis, pain of rheumatism & arthritis.
- > Improves circulation.
- > Stimulates the lymphatic system.
- > Tautens the skin and connective tissue.
- > Has a slimming effect.

FEATURES.

- > 60 to 290 water and air nozzles offer optimum pulsating vibration and jet massage.
- > Ergonomic massages based on the reflex zones. The nozzles are directed heartward.
- > Air admixture by up to 8 water jet pumps.
- > Individual programming of the massage possible.
- > Option: automated disinfection program.



HYGIENE.

The Hydroxeur[®] principle involves air being injected directly into the water pipes. All air and water nozzles are supplied by the same system which means, cleaning solutions and disinfectant are taken to hard-to-reach places.

The automated disinfecting programmes take care of hygiene, so you don't have to.

SAFETY & DESIGN.

Your safety is one of our greatest concerns, which is why we have equipped the Hydroxeur[®] with handles to ensure a safe bathing experience, and an adjustable shortener to provide optimum support. An optional, integrated step also makes it easier to get in and out of the tub. With an optional mounting frame the Hydroxeur[®] will perfectly fit into your bathroom or spa interior.

Shorter models.

Surround yourself with the finest swirls of air and a myriad of tiny bubbles, bathe in a rainbow of colourful lighting and breathe in the finest of nature's fragrances. Enjoy gentle music and a rhythmic massage and in doing so, bid the stress of your day farewell. Pamper all your senses. Your new-found balance will have a positive effect on every aspect of your life. The Hydroxeur® is your very own therapist and offers complete relaxation with its wide variety of functions.



Control panel
FLORIDA 100



Control panel
CALIFORNIA 100



Control panel
DIANE 100

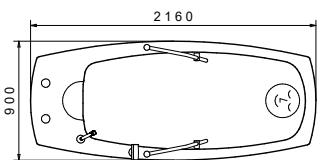
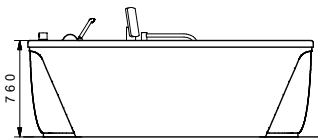

Dimensions
Florida 100
California 100
Diane 100

HYDROXEUR® >
with holding bow
and hand rails

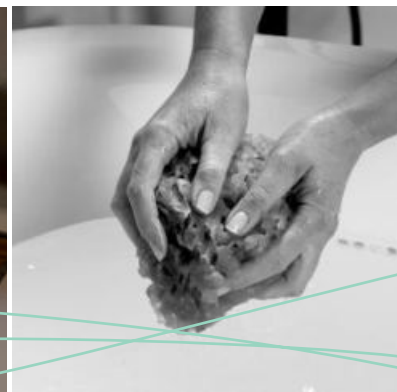

CONTROLS.

- > Individually adjustable programmes.
- > Standard programmes.
- > Individual body zones can be turned on or off.
- > Customized treatment times.
- > Constant massage using all nozzles.
- > Bath is filled, emptied and cleaned automatically.

ACCESSORIES AND SPECIAL OPTIONS.

- > Massaging hose for individual treatment.
- > Additional jets for a more intensive massage.
- > Color light module for the proper well-being.
- > Comfortable automatied tub filling and draining (standard).
- > A soft pillow with air cushion (standard).

Hydroxeur®-Couple Bathtub.

HYDROXEUR® CALIFORNIA TWIN

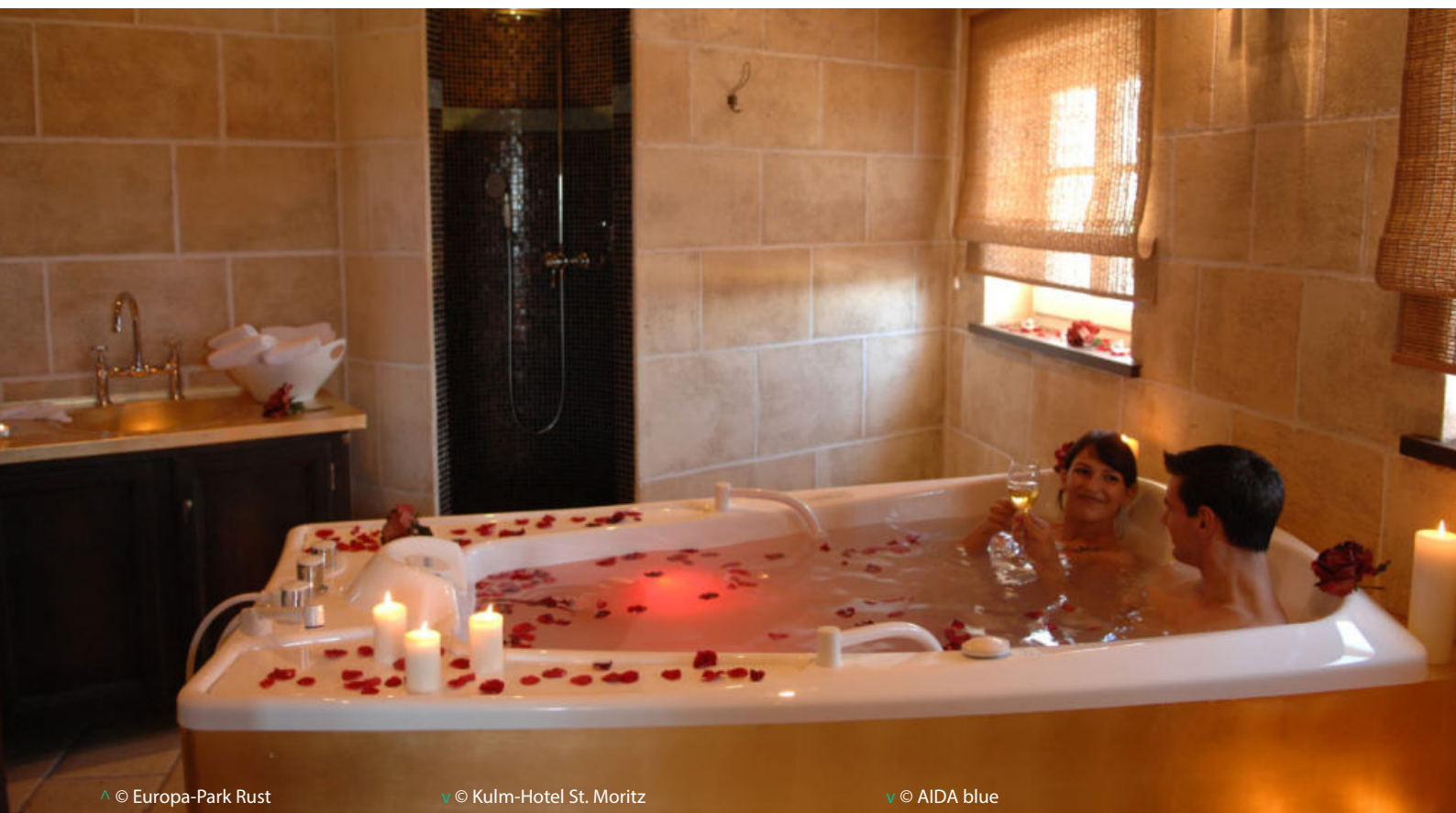

^ © Europa-Park Rust

v © Kulm-Hotel St. Moritz

v © AIDA blue



CALIFORNIA TWIN, RENDEZVOUS & YIN YANG.

Exceptional bathtubs for couples in different shapes but with the same functions. In the California Twin you sit next to each other, whilst in the Rendezvous you sit on opposite sides. The Yin Yang offers each bather its own bathing water.

VERSATILITY.

Ideal for economical use in wellness centers or as an oasis of relaxation in the sophisticated private area. Due to the high ease of use, Hydroxeur® couple tubs are also ideally suited for hotel suites. From fragrant aromatherapy and thalasso treatments to massage and relaxation baths, an exclusive bathing experience is offered.

Well-being for two.

Trautwein is the only manufacturer in the world to offer Hydroxeur® whirl bathtubs designed for two persons bathing together – the California Twin, the Rendezvous and the Yin Yang.

As with all our Hydroxeur® bathtubs, they offer four forms of Wellness: colour light therapy, water and air massage, sound wave massage and aroma therapy.

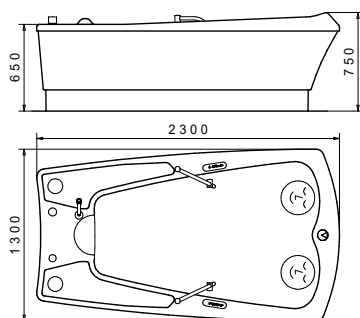

California Twin dimensions



Plastic cladding
California Twin, white.



Bathing guests can choose their favourite programme for the California Twin and Rendezvous by using the easy-to-operate controls.



The water flows into the bath silently via the cascade filler neck. The two-stage bath shortener provides safe bathing.

✓ CALIFORNIA TWIN, tiled



✓ CALIFORNIA TWIN, with plastic cladding and outer lighting.



COMFORT OF HANDLING.

At the push of a button, the California Twin and the Rendezvous are filled with water to the exact level. Using our Hydroxeur® principle, all air and water nozzles are supplied through one canal system. This way, cleaning and disinfection agents can reach even hard-to-access areas. If desired, by using the automated disinfection programme.

DESIGN CALIFORNIA TWIN.

The California Twin can be delivered with a plastic cladding in a choice of different colours. In addition, a very beautiful effect can be created using indirect lighting on the cladding. As an alternative, a tile-in frame is available that can be cladded with tiles or wood on site.

Hydroxeur® Couple Bathtub.

HYDROXEUR® RENDEZVOUS

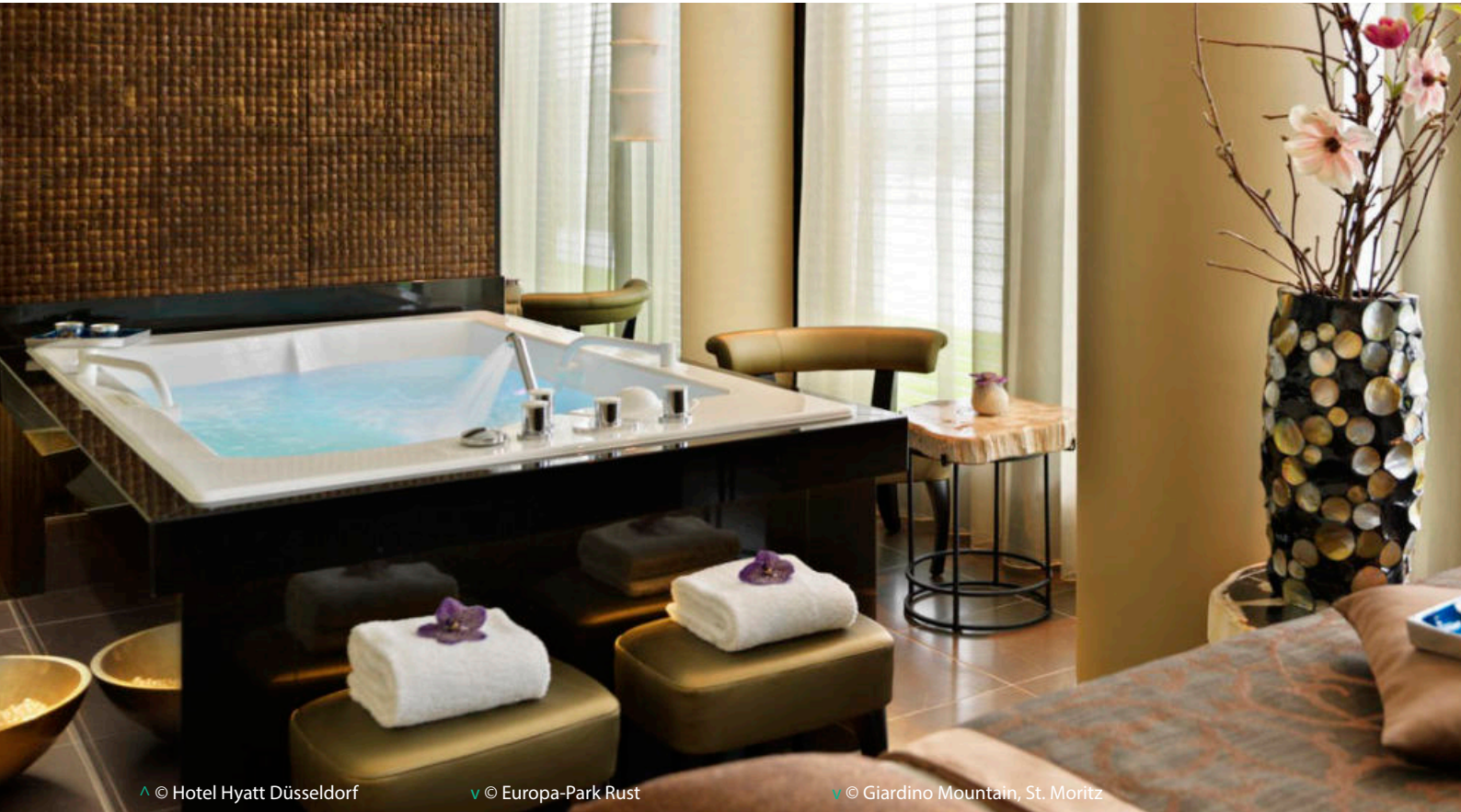

^ © Hotel Hyatt Düsseldorf

v © Europa-Park Rust

v © Giardino Mountain, St. Moritz



INTENSELY TINGLING MASSAGE.

The California Twin & Rendezvous couple bathtubs massage two bathers with 120 water and air nozzles. The fine whirling air and water swirls of the surge bath bring about relaxation, recovery and new energy. The Hydroxeur® principle creates an incomparably intense sensation that remains stored in the water for minutes... our fabled champagne effect! (Optional for Yin Yang couple bathtub.)

SOUND WAVE MASSAGE.

Dive into the world of sound. Be it rock, pop, classic or special relaxation music, the sound you will hear in our Hydroxeur® bathtubs is crystal clear. The bathtub itself serves as the speaker and transmits sound waves through the water to the bather. Music is perceived in a totally unique way... as sound through the ears and also as vibrations through the body.

Spoiling with surplus value.

Hydroxeur® couple bathtubs offer more – an extraordinary Wellness experience that guests will remember positively for a long time, plus an inviting financial yield for the investor.

The time, couples spend together is precious which is, why an increasing number of couples like to enjoy their Wellness experience together, making couple's treatments a current trend.

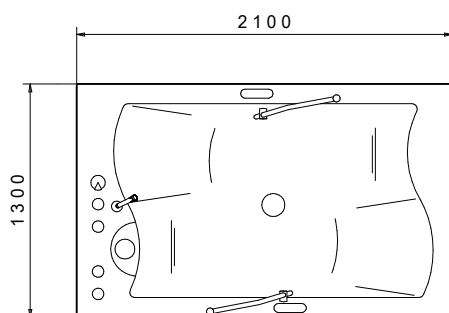

Rendezvous Dimensions



By pressing the button, the couple baths are filled to exactly the required level.

Integrated thermostats ensure the water is always the desired temperature.

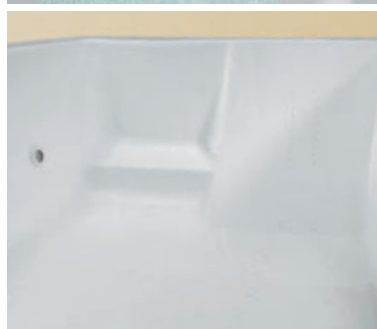

In the ergonomically designed bathtub, the bathers relax in a seated position. A bath shortener on both sides, built-in at the foot zone, adds to the bather's comfort and security.



The two bathers sit facing each other.



An additional thermostat (option) provides an even quicker filling of the bath.

COLOUR LIGHT MODULE.

The flicker-free, full spectrum underwater illumination provided by the integrated high-performance lights, tints the bathing water in atmospheric rainbow colours. Coloured light has a regenerating and revitalising effect on mind and emotions. The lighting can be adjusted to show either the full colour spectrum or a single colour – the choice is yours.

RENDEZVOUS DESIGN.

The Rendezvous is delivered with a tile-in frame that can be adapted and clad with tiles or wood on site. This way, it can be individually customised and integrated into a home bathing area, hotel suite, Wellness centre or a recovery institution.

Yin Yang Couple Bathtub.

YIN YANG with on-site wood cladding



WELLNESS FOR COUPLES.

The time spend together is getting more and more precious. Common treatments are thus in great demand – the tendency for couple treatments is proving this very clearly. However, not only couples, but also close friends, or mother & daughter could enjoy spending this pleasant time together. For this purpose, the Yin Yang for two persons is the optimal tub.

SPECIAL FEATURES.

- > Sound wave massage with 8 color diods, 4 per tub.
- > Automatic filling - each tub can be operated separately.
- > Per tub: fittings with blocking valves, thermostats and hand shower, excenter drain and overflow.
- > Optional: Hydroxeur® massage module with 60 jets per tub..

TOGETHER, YET INDIVIDUALLY.

With the Yin Yang couple bathtub, each bather has its own bathing water. Temperature, bath additives and the color of the light can be chosen individually. Separating the bathing water is also a good solution in terms of hygiene.

If only one person wants to take a bath, only half of the bathing water is needed!

The Yin Yang couple bathtub offers its bathers a luxurious bath with tingling sound wave massage and vitalising colored light. If requested, this bathtub can also be equipped with a Hydroxeur® massage module.

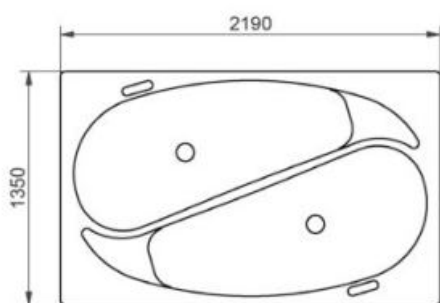

Yin Yang dimensions

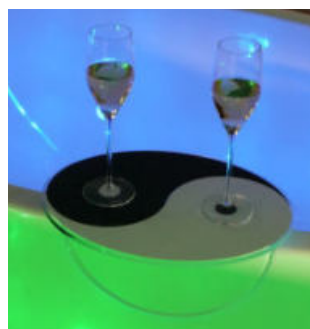

< The attachable tray table is a handy and nice accessory.

✓ Taller bathing guests will certainly appreciate the generous space. An integrated bath shortener gives security and well-being to smaller bathing guests.



The tub edge is drawn down in the middle, so that the bathing experience can be intensified.

DESIGN.

The Yin Yang couple bathtub is delivered with a tile-in frame, which can be customized on-site and clad with, e.g., tiles or wood. This way, the couple bathtub's exterior can be designed individually and fitted perfectly to the premises in the Wellness area.

YIN YANG COUPLE BATHTUB.

This bathtub offers the possibility of bathing together, yet separately. The form of the tub reminds the Chinese symbol Yin and Yang, which expresses the constant change of the opposites.

Vis à Vis & Sole Mio Wellness Bathtubs.

VIS À VIS
for single and couple baths



TINGLY SOUND WAVE MASSAGE.

Immerse yourself into the world of sound. Whether it's rock, pop, classic or special relaxation music, the sound in our Wellness bathtubs is crystal clear. The bathtub itself serves as the speaker and transmits the sound waves through the water to the bather. The music is perceived in a totally unique way... as sound through the ears and also as vibrations through the body.

18

UNDERWATER COLOR LIGHT.

Four high-powered colored lights illuminate the water in flicker-free and atmospheric colors of the rainbow. This has a regenerative and revitalising effect. The phenomenon of winter depression or spring feelings show how important light is for us. It does not only put us in a good mood, it also stimulates healing processes.

Feeling the sound in the body.

Dive into the world of sound. Breathe in wonderful aromas while accompanied by atmospheric light. The Vis à Vis offers a unique combination of a variety of types of wellness: by using sound waves and colored light, a most effective micro-massage of all cells, organs and body parts is effected. The mind is also positively affected. The bather's entire sensory and motor system is noticeably activated. The Vis à Vis has room for one or two persons, whereas the Solo Mio is designed just for one person.

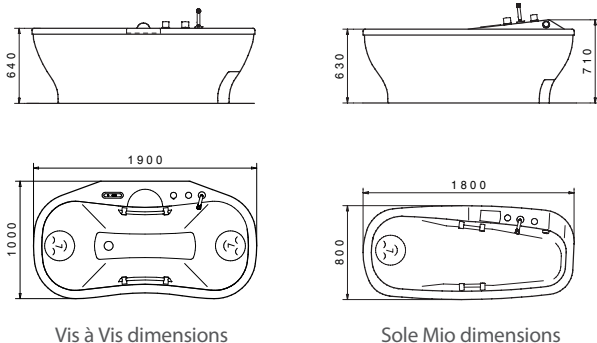

By pressing the button, the Vis à Vis is filled with water to exactly the required level. Integrated thermostats ensure, the water is always at the desired temperature.



The Sole Mio has space for one person.



The Vis à Vis has space for one or two persons.

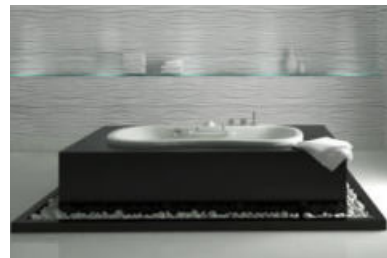

All bathtubs can optionally be supplied with a tile-in frame for individual on-site adaptation to the surrounding room.



The oil dispersion shower can be connected to any conventional shower hose.

AROMATHERAPY & OIL DISPERSION BATH.

With according bath additives, the bathing experience can be turned into a true feast for the senses. The oil dispersion shower binds high-quality oil in millions of fine droplets in the bathing water. This way, it can be perfectly absorbed by the skin, leaving it as smooth as silk.

Vis à Vis 1000 Couple Bathtub.



COMPACT, ELEGANT DESIGN.

The rectangular outer form makes various arrangements possible. For the corner solution with cladding, wall connection blinds are supplied. Alternatively, a mounting frame is available, which can be, e.g. tiled or clad with wood on-site. This way, it can be arranged individually and perfectly matched to the ambiance of the room.

INTENSE UNDERWATER MASSAGE.

Immerse yourself into millions of the finest air and water whirls. Have yourself massaged and forget the strains of daily life. Eighty strong Hydroxeur® massage nozzles create an intense, top-class underwater massage. The air is micro-finely injected into the water, which produces a precious “Champagne” effect. An unbelievable feeling (Option).

Underwater massage on demand.

The Vis à Vis 1000 has the same inner form as the Vis à Vis, but is rectangular on the outside. It can be equipped with 80 powerful Hydroxeur®-massaging jets on demand.

The Vis à Vis 1000 spoils guests in the spas of hotels, suites, beauty parlours and individuals in their private spa.

The Vis à Vis 1000 has room for one or two persons.

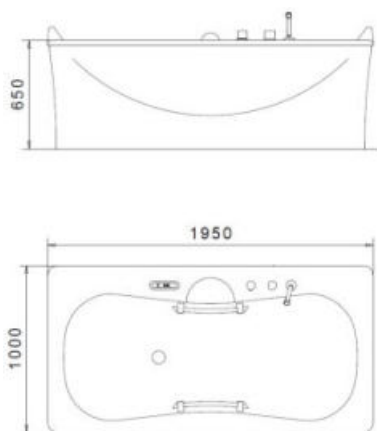

Vis à Vis 1000 dimensions



FEATURES.

- > With sound wave massage and four color lights.
- > Automated filling for one or two persons.
- > Hansgrohe fittings with block valves, thermostat and hand shower.
- > Excenter drain and overflow.
- > Hydroxeur®-Massage with 80 jets (option).

TECHNICAL DETAILS.

- > Electricity supply: 230 V, 50 Hz.
- > Disinfection with chlorine granules.
- > Bath shorteners for single bathers and security handles.
- > Water consumption: single bath approx. 190 l; couple bath approx. 170 l.
- > Optional: LED-ambience lighting on the outer tub rim.
- > Cladding colors on demand.

Twaèli Thermo- & Relaxation Couch.

TWAÈLI

Upper shell of the couch black, bottom side of the couch white, pillows light-grey



THERMO- AND RELAXATION COUCH.

A tender, tingly feeling flows through your body to the rhythm of the music. You will hear gentle sounds and feel harmonious vibrations in every fibre of your being and with all your senses. Daily routine will disappear and give way to relaxation and well-being. The heated, ergonomically-designed lying surface with soft pillows will spoil you at the highest level of comfort.

22

FOR RECOVERY AND WELL-BEING.

The couch with an unbeatable relaxation factor spoils whenever you feel the need for it – after the sauna, at the end of a stressful day or simply in-between treatments. Developed for modern professional sauna and wellness resorts, the Twaèli can equally enrich a luxurious private home.

Viability and Well-being.

Depending on the equipment, the Twaèli is a chic and comfortable thermo couch or, when fully equipped with sound wave massage, offers a warming, soothing effect on the body, mind and soul. Any genre of music can be played by means of an in-house audio system. The sound is crystal-clear, with the sound waves transmitted to the couch by a special technique. Ideal for recreation and relaxation, the Twaèli Design Couch meets most requirements.

By special order, the Twaèli can also be delivered without heat or sound – simply as a comfortable, modern relaxation bed.



The couch is available in black or white, the pillows in red or light grey. Other pillow colours are available on demand.



The hygienic smooth lying surface is of high-quality acrylic and easy to clean.



In case of the model with sound wave massage, the operation is done via the ergonomically arranged and comfortable control panel. Temperature and sound volume can be adjusted individually.



The adjustable headrest is set to the desired position by a handle.

Twaèli – Thermo- & Relaxation Couch	
Length x width	1750 x 820 mm
Height	420/930 mm
Weight	70 kg
Loading capacity	200 kg
Electrical connection	230 V, 50 Hz, 150 W

EQUIPMENT VARIANTS.

- > Thermo couch: basic equipment with heating unit.
- > Thermo- and relaxation couch: additional sound wave massage available (option).
- > Design couch: no heat nor sound.

Thermo-Spa & Lady-Spa.

THERMO-SPA
Designer cladding white



THERMO-SPA & LADY-SPA.

The Lady-Spa is the smaller version of the Thermo-Spa. Both floating couches can be equipped with various options. The Lady-Spa, with its smaller dimensions, was created particularly for small rooms and offers flexible use in spas, hotels, cosmetic institutes and in physical therapy centres.

APPLICATIONS & EFFECT.

Our floating couch gives you an indescribable feeling of weightlessness. Depending on the options you choose, it also pampers you with sound waves and dry aqua massage. Both these products offer many benefits of floatation... without the need to change clothes. You are separated from the warm water by a layer of durable yet fully flexible plastic, giving a deeply relaxing experience that is reminiscent of being in the womb.

Floating on Sounds.

When you experience our Thermo-Spa and Lady-Spa, weightlessness spreads slowly throughout your body and you feel incredibly light. Surrounded by relaxing warmth, a primordial feeling of security frees your body and mind from stress and discomfort. As soft sounds reach the ears and harmonious vibrations gently reverberate throughout the body, physical imbalances and everyday worries seem to melt away. Welcome to the world of Thermo-Spa & Lady-Spa, a unique wellness experience from Trautwein.



Design cladding, two colours, optional exterior lighting.

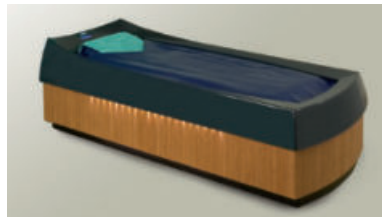

Design cladding, with bamboo, optional exterior lighting.



Standard cladding, plain.



Standard cladding black with carbon appearance.



SOFT PACK APPLICATIONS.

Our floating couches are suitable for all sorts of therapeutic and cosmetic body packs – from algae, hay and pomace to mud and fango. The guest lies down on the cushioned bed and is wrapped in a soft blanket. The warmth enhances circulation and opens the pores, allowing the skin to absorb the active ingredients for optimum results.

DESIGN.

We have the perfect cladding design to match the ambience of any room. For colour and material selection, all the illustrated options, plus numerous others, are available. Simply let us know, what you are looking for and we will find a way to make it happen.

Thermo-Spa & Lady-Spa.

LADY-SPA
with standard cladding



WELL-BEING MODULE CONCERTO (OPTIONAL).

With the floating couch itself working as a loud speaker, the water on which you float vibrates allowing the sound you hear to be felt in your body. A unique Trautwein experience that has been described as out of this world!

Flexible all-rounder.

Just like every other Trautwein product, the Thermo-Spa & Lady-Spa meet all the highest quality standards which are aligned with our philosophy. Many clever design details guarantee maximum comfort, even when used frequently. The Thermo-Spa is well-equipped for any challenge, with advanced and easy-to-use technology, it can be used for therapeutic and cosmetic purposes.

With the optional above- >
head-display, the guest
can operate the Thermo-
Spa without any help
from others.



Optional 3-piece overlay >
for massages.



AQUAJET MASSAGE MODULE (OPTIONAL).

Like an experienced therapist, our floating couches massage from the thighs to the neck. Temperature-regulated water jets are expelled against the underside of the bed surface, releasing muscle tension whilst allowing you to experience the healing power of hydromassage without getting wet.

OPTIONAL MASSAGE OVERLAY (OPTIONAL).

The light and soft overlay is simply put onto the floating couch. Thanks to this, it is possible to offer different treatments in one room. The height-adjustable couch allows the client to get securely on and off, and also provides a good working posture for the therapist.

Thermo-Spa & Lady-Spa.

THERMO-SPA
with Aura colour light module

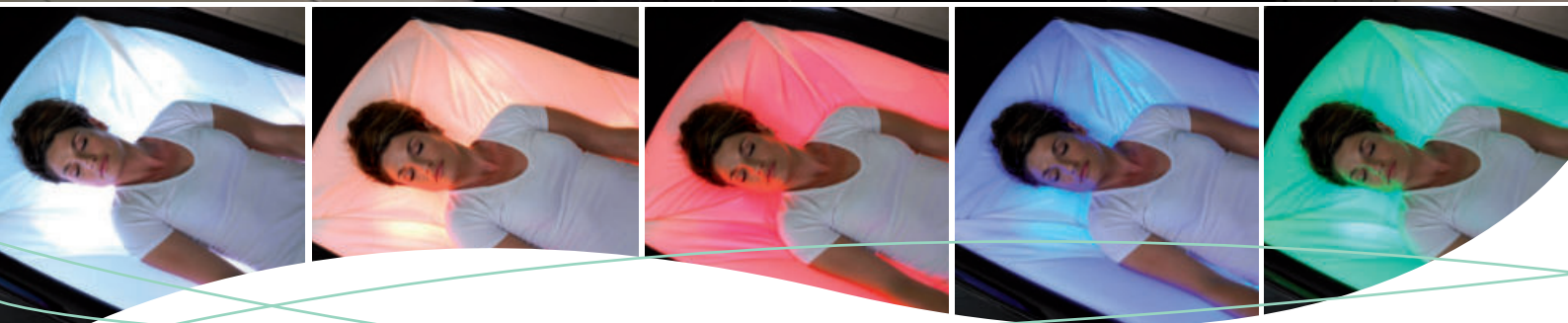

AURA COLOUR LIGHT MODULE (OPTION).

Floating in the light: When the integrated, flicker-free, high power coloured LED lights are illuminated, the translucent special foil shimmers with atmospheric rainbow colours and the guest floats directly on a sea of revitalising and regenerating light.

If you choose so, the lights can be adjusted to show only your favourite colour. Available in both, the Thermo-Spa & Lady-Spa.

An all-rounder for narrow places.

The Thermo-Spa & Lady-Spa floating couches allow professional whole body beauty treatments or heat packs to be offered simultaneously with the float, sound and colour experiences. Due to reduced therapist input and the possibility of parallel use they are very profitable. The guest gets pampered and relaxes, allowing the therapist turning to other tasks. Connection in the room is kept simple – only a 230 V power socket is needed.

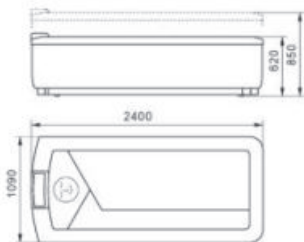

Thermo-Spa dimensions
standard cladding

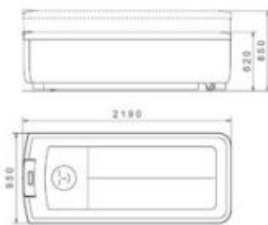

Lady-Spa dimensions
standard cladding

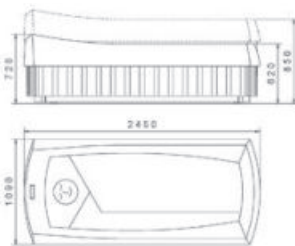

Thermo-Spa dimensions
design cladding

Heating device >

Floating Couch	Thermo-Spa	Lady-Spa
Length x width	2450 mm x 1090 mm	2190 mm x 950 mm
Height in lowered position	620 mm (chair height)	620 mm (chair height)
Height in raised position	850 mm	850 mm
Weight without water / with water	230 kg / 580 kg	210 kg / 520 kg
Floor load	340 kp/m ²	260 kp/m ²
Power supply	230 V, 50 Hz, 2500 Watt	
Options	<ul style="list-style-type: none"> > Concerto well-being module > AquaJet-massage-module > Aura Colour light module > Exterior lighting for design cladding > Massage overlay 	

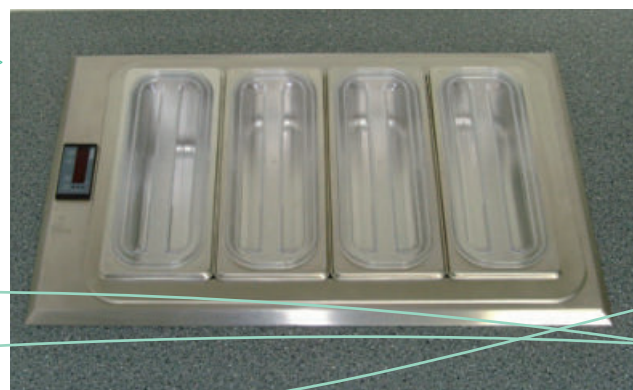

EFFECT OF THE FLOATING BED.

- > Warming and relaxation of the muscles.
- > Increased blood circulation.
- > Relief of the joints, pelvic, spine and the complete skeleton. Pain can be reduced.
- > Very good effects on depression and sleeping problems, inner unrest and stress.

HEATING DEVICE (OPTION).

Useful for heating and keeping cosmetic products, e.g., algae, oil, mud or stones for hot-stone treatments, warm. Design of this feature is discreet as it is set into the working plate, with a discharge cock and digital controls for ease of use.

The AquaThermoJet-Large.

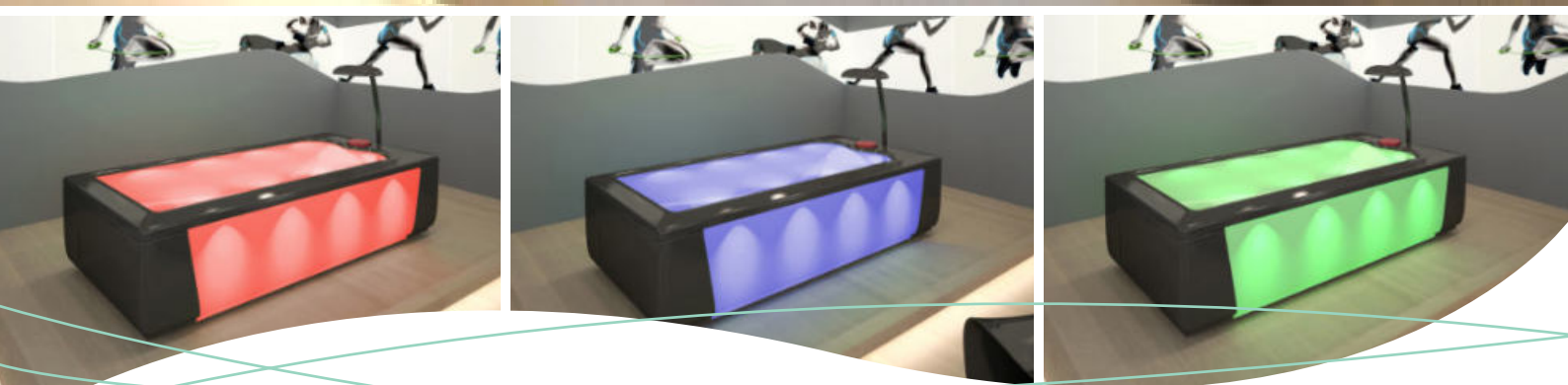

EFFECTIVE AND SOOTHING TREATMENTS.

32 rotating water jet nozzles are integrated ergonomically in 7 zones split from feet to neck. 3 standard and 9 individual programs can be combined with 5 pressure levels. The user can choose between 60 possible variations.

The massage is performed in circular movements in direction of the heart, like during the treatment of a physiotherapist.

So simple – select your menu and enjoy pure pleasure.

FLEXIBLE & SAFE & COMFORTABLE.

The smart, patented technology allows the user to leave the AquaThermoJet at any time during the treatment without affecting the functioning of the device. The low height (chair height) makes it easy to get on and off the AquaThermoJet.

An integrated padded head rest guarantees ultimate comfort.

A cooling system is serially integrated.

Watermassage for the well-being.

Back pain and states of fatigue due to a lack of physical activity and too much strain often lead to a reduced quality of life. The 32 rotating water jet nozzles of the AquaThermoJet are integrated ergonomically in 7 zones and relax the body from the feet up to the shoulders. The massage is performed in circular movements in direction of the heart, like during the treatment of a physiotherapist. The soft and comfortable film of the surface and the soothing warm water jets relax the muscles and increase the personal well-being. The AquaThermoJet offers an attractive, reasonable and inexpensive alternative to a manual massage at any time, whenever you want.



The user can select his program without help while resting on the surface. The menu and the use of the AquaThermoJet are easy to understand.



The control panel can be swiveled by 180° and, therefore, be easily operated by the personnel in an upright and back-saving position.

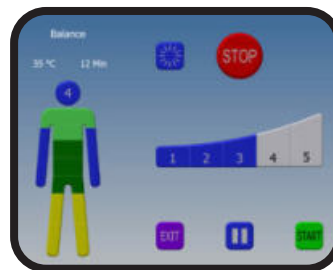

The touch screen of the AquaThermoJet is easy to understand. All programs and treatments are displayed in a very clear and comprehensive way.

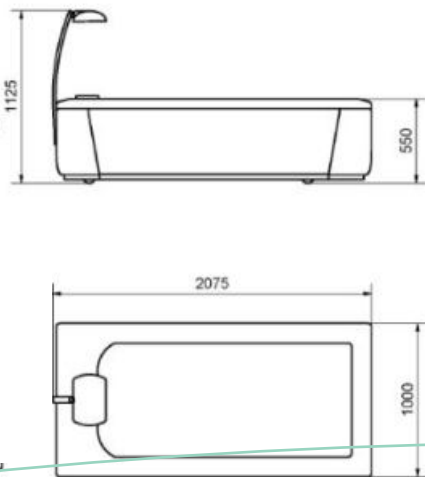

AquaThermoJet dimensions



DESIGN, LIGHT AND EFFECT.

Option: External Lighting.

The lateral cladding and the translucent surface are illuminated in all the colours of the rainbow and bathe the room in a pleasant light. The colours change automatically. A particular colour can be selected as well. The cladding is available in white or black.

This option makes the AquaThermoJet also optically a real highlight!

POSSIBLE WAYS OF USE.

The AquaThermoJet is excellently suitable for the use in wellness areas, beauty centers and gyms, where it can be used on a self-serving basis with a coin-operated machine. It can also be used for physical relaxation in doctor practices as well as in companies with health management.

AquaThermoJet.



AQUAJET MASSAGE.

Like an experienced physiotherapist, the AquaThermoJet massages from the thighs to the neck. Instead of therapist's hands, you feel temperature-regulated water jets that massage through the layer of plastic. You experience the healing power of water without getting wet. The AquaThermoJet massages six body zones via 24 nozzles.

EFFECT.

- > Relieves tension.
- > Improves circulation and metabolism.
- > Tightens the connective tissue.
- > Stimulates the lymphatic system.
- > Reduces stress.
- > Improves the well-being.

Massage and relaxation.

The AquaThermoJet is convincing due to its flexibility of use. It is perfectly suited for Wellness, Beauty and Fitness centers where it can be self-service operated, by coin-machine if required. It is also used in medical practices or companies that provide health management for relaxation, as well as an offering provided between other medical treatments.

The touchtronic control is easy to operate and can be turned by 180° allowing it to be easily controlled by guests when they are lying down, or by a therapist standing above.

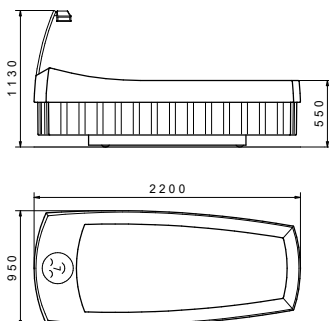

AquaThermoJet dimensions



Cladding, with lighting, plain.



Cladding, with bamboo and lighting, plain.



Cladding, two colours.

	AquaThermoJet-Large	AquaThermoJet
Length x width x height	(2075 x 1000 x 550)	(2200 x 950 x 550) mm
Suitable for	people up to 1,9 m	people up to 2 m
Weight empty / filled	230 kg /480 kg	130 kg /280 kg
Floor load	280 kp/m ²	140 kp/m ²

INCREASED PROFITABILITY.

As the AquaThermoJet is so easy to operate, guests can enjoy it on their own. This means, you have another wellness attraction without requiring additional personnel.

Depending on the number of applications and the pricing of treatments, the AquaThermoJet can return its investment in just one year.

Ergolima Wet Massage Table.

ERGOLIMA WET MASSAGE TABLE
Lying surface and socle cladding black



COMFORT FOR THE GUEST.

- > Adjustable head rest with nose slit.
- > Specially shaped arm rests for comfortable relaxation in the ventral position.
- > Table can be lowered to chair height for getting on and off safely.
- > Spacious lying surface, suitable for average & larger guests.
- > Thermostatically heated, pleasant lying surface.

COMFORT FOR THE THERAPIST.

- > Fully height-adjustable to allow an ergonomic posture – helps to minimise the risk of occupational injury.
- > Thermostat, changing valve, hand shower and pouring hose are fixed onto the rim of the table, all within easy reach.
- > Easy operation by a console in the table frame.
- > Channels on the side of the table, plus drains and a gently angled lying surface facilitate the draining of liquids.

Maximum treatment comfort.

The luxurious Ergolima Wet Massage Table offers unsurpassed comfort for wet treatments. Its heated surface allows to relax in a ventral position with arms resting on the ergonomically shaped plateau next to the body.

The head support is adjustable and can be positioned to meet personal requirements. With this high level of comfort you can really enjoy wet treatments such as soap brush massages, peelings, hammam or ayurvedic treatments. The Ergolima is patented, made of a high-quality, textured acrylic glass and is available in black or white (special colors on demand). As with all of our products it is manufactured to the highest levels of excellence.

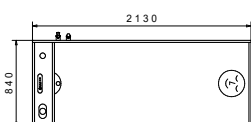
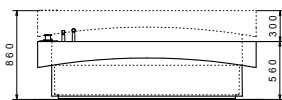

Orient Wet Massage Table
with granite surface
dimensions

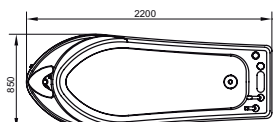
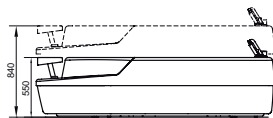

Ergolima dimensions



Height-adjustable head piece and lateral arm supports. Drain at the head piece, suitable for collecting oils.



Orient-Alima Wet Massage Table, lying surface white with plastic cladding white.



Wet Massage Table, with granite surface. Cladding with Bamboo.



Wet Massage Table with lifted socle cladding. Standard for better cleaning.

DESIGN.

Our Wet Massage Tables offer many design options. In addition to the acrylic, textured surface (available in four colours), we also offer different types of natural stone. This variety allows to choose whichever style suits your interior design the best. Alternatively to the Ergolima, but without height-adjustment, the Ergolima 800 can be offered.

SOPHISTICATED TO DETAIL.

The socle cladding below the lying surface can – in all models – be elevated electrically at the touch of a button. This is ideal for cleaning and servicing. Optionally, a soap foam dispenser can also be installed.

Vichy-Rainbow-Shower.

VICHY-RAINBOW-SHOWER



RANGE OF USE.

The pleasant, relaxing and revitalising whole body shower treatments taken with a Vichy shower have a long-standing tradition. They are especially well-proven in hydro and Thalasso therapy, as well as in gyms, spa and wellness centers.

EFFECT.

The regular, evenly-applied shower can improve blood circulation resulting in enhanced oxygen transfer, plus purification and detoxication of the skin and internal organs. After a Vichy Rainbow Shower you will feel relaxed, refreshed and your skin will feel tighter. The soul relaxes.

A tingly showering pleasure.

The Trautwein Vichy Rainbow Shower offers a brand new and unique shower experience using sophisticated technology coupled with exceptional design. The shower head is equipped with micro nozzles assembled in two rows. It sways back and forth, showering the body from feet up to neck. Very fine water jets massage the body simulating sea waves, a gentle rain shower or intensely stimulating drops – the choice is yours.

Dissolved salt or nurturing oils can be added to the water to further increase the sense of well-being. The water flows over sparkling Swarovski crystals that diffuse flicker-free coloured LED light onto the body for the ultimate relaxation shower. The Vichy Rainbow Shower needs 150-250 litres of water per treatment, the same as for a bath.

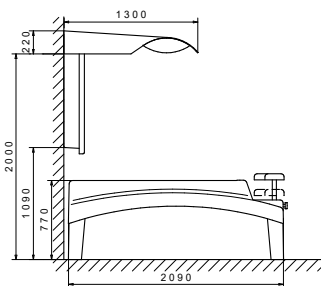

Vichy-Rainbow-Shower
Dimensions

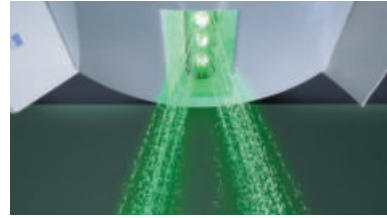

Shower jets with shiny coloured light.

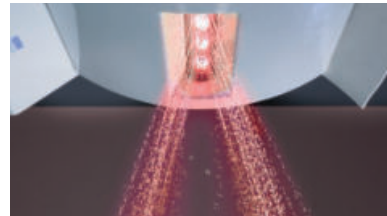
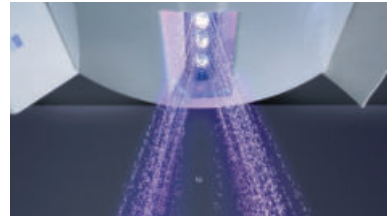

The couch provides optimal comfort for ventral as well as dorsal position.



The face remains almost completely dry due to the insertable and adjustable splash guard.

CONTROL PANEL.

The duration of the shower, the mixing of additives / salts and the disinfection cycle is regulated via a control panel. A thermostat ensures the perfect water temperature and removes the risk of scalding. Using a hand key the guest can integrate short, cold shower phases into the treatment to stimulate circulation.

VICHY COUCH.

The comfortable couch made of plastic material is ideally suited to wet areas. The lying surface is made of high-quality, textured acrylic glass. It has a high degree of comfort due to the height-adjustable head board, the lower-positioned arm supports and the splash guard.

Final notes.

FOR THE PLANNING OF TREATMENT ROOMS IN A SPA OR WELLNESS AREA

ROOM PLANNING

A balanced number of rooms for staff-intensive and less staff intensive treatments are the foundation of a profitable spa.

ROOM DESIGN

Create a harmonious atmosphere in which both, the guest and the therapist, feel comfortable. You can achieve a great deal with little means by using intelligent interior architecture. Only invest in expensive decor, ceramics or furnishings if there is ample budget.

HARDWARE = TREATMENT APPLIANCES

The cost-effectiveness of a spa installation is increased by offering treatments where therapist input is kept to a minimum. Manual treatments such as massages or beauty treatments are essential components of a spa menu and can be perfectly complemented with a Thermo-Spa for floatation and soft pack treatments, and a Wellness bath or shower for a relaxing and revitalising bathing experience.

QUALITY OF TREATMENTS

If you offer a bathing experience, it needs to be a special Wellness bath that truly spoils your guest with underwater massage, sound wave massage and coloured light. A unique experience that cannot be recreated at home!

SPA RECEPTION

The spa reception is of central importance and should be located in a place where many people pass by. The person responsible must be able to sell. By establishing the guest's wishes, they can sell the appropriate treatment. Volume and the returns are governed by the booking efficiency of the spa reception team and by their ability to optimise capacity.

COMPETENT STAFF

Qualified staff is the basic prerequisite for a prosperous spa. Bear in mind, that your team should know all the treatments on the menu. Inviting your staff to experience the treatments themselves, is the best way to ensure they can sell them in a convincing way.

IN-HOUSE ADVERTISEMENT FOR THE SPA

Offering hotel guests a voucher for a treatment free of charge on their arrival is an ideal way of attracting business to the spa. If you offer a short session in a Thermo-Spa without any products, at little cost to the operation, you have a good opportunity to upsell the guest a paying treatment.

If you have short notice availability in the spa, it can be advertised as „Last Minute Wellness“ in high footfall places such as the hotel lobby, elevators, lounge, etc.

World-renowned and highly rated.

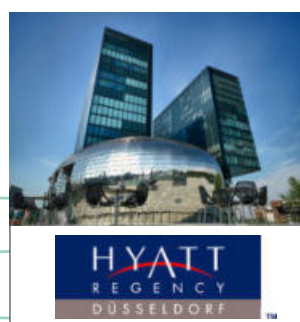
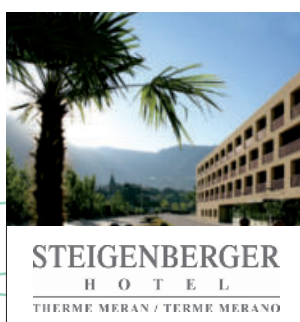
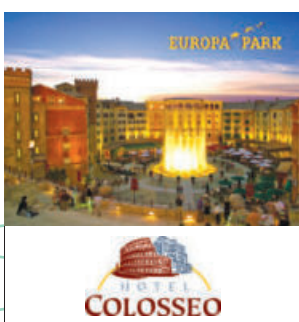
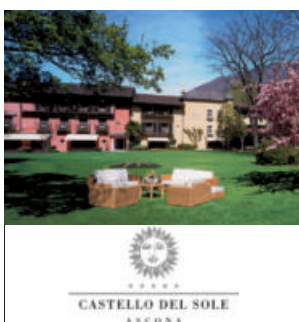
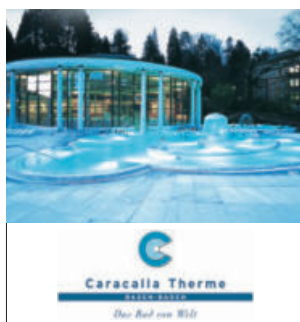
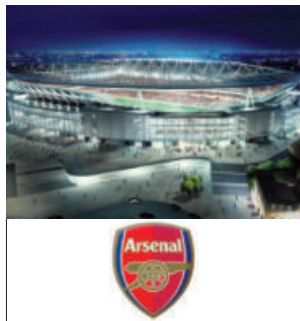

THE WORLD TRUSTS TRAUTWEIN.

...especially when it comes to high-end products for the wellness industry, physical therapy and nursing. Trautwein baths and wellness systems are installed in hotels, therapeutic practices, nursing homes and private homes – anywhere people like to relax or enjoy a treatment.

Over 10,000 satisfied customers all over the world value our expertise and ability to meet individual needs – in design and functionality. Trautwein stands for well-being in every respect. Here you will find a selection of internationally renowned hotels that pamper their guests with Trautwein products.

Environment-friendly production. Made in Germany.

We take a responsible approach to the environment and the next generation. Our 1.800 m² solar power plant generates about 190.000 kwh/year of environmentally friendly power, which is the equivalent of the annual electricity consumption of 65 four-person homes. We produce far more energy, than we require ourselves.

In 2002, Trautwein GmbH received an award from the WWF for its commitment to the environment. We try to reduce waste and limit the impact of our products on the environment, from product development to packaging.



Trautwein GmbH
Denzlinger Straße 12
79312 Emmendingen
Germany



Tel. +49(0)7641/4677-30
Fax +49(0)7641/4677-70
info@trautwein-gmbh.com
www.trautwein-gmbh.com

Technology for all Senses. **TRAUTWEIN**

Reserve technical changes.